

FD 960-22 RS

Double Convolution Air Actuator

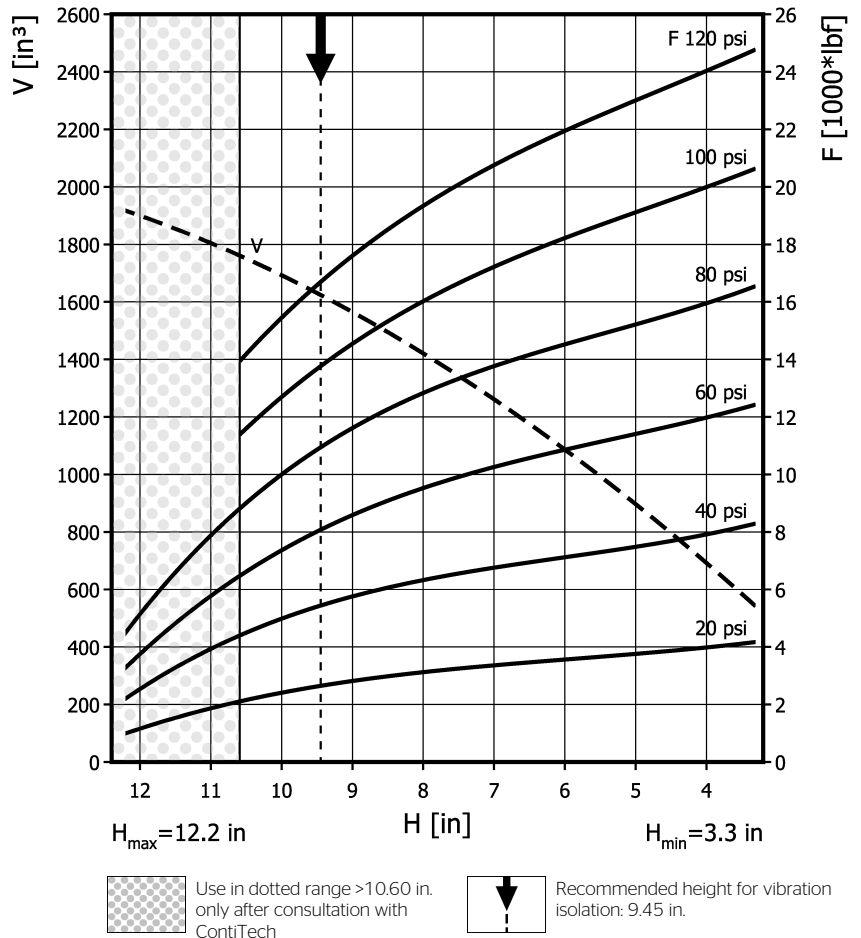
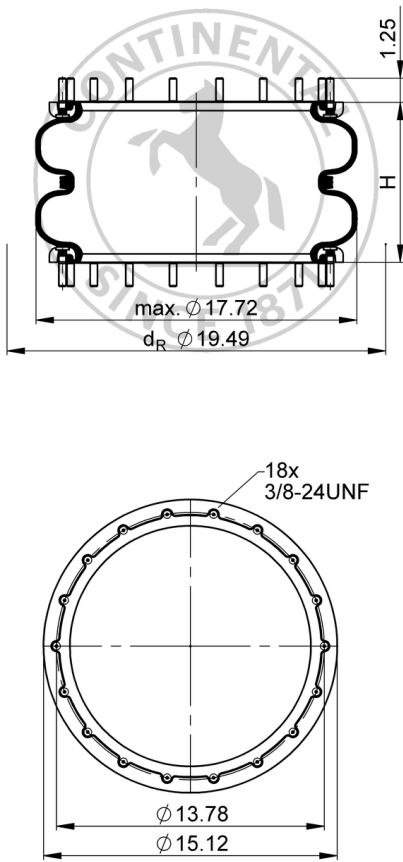

Purchase order data

Type	Order No.
rubber bellows only	61776
with bead rings, 1 7/8in bolts, nuts and washers	65890

Additional types on request

Technical data

Min. pressure	0 psi
Return force to min height	≤ 45 lbf
Overall weight	19 lb

Vibration isolation - dynamic characteristic values

Design height H: recommended 9.45 inch, minimum 8.66 inch

Pressure p [psi]	40	60	80	100	120	Vol. V [in.³]
Force (Load) [lbf]	5740	8230	11300	14000	16600	
Spring rate [lbf/in.]	1670	2290	2970	3640	4310	
Natural frequency [Hz]	1.7	1.7	1.6	1.6	1.6	

Pneumatic application - static characteristic values

Force F [lbf]

Pressure p [psi]	40	60	80	100	120	Vol. V [in.³]	
Height H [in.]	9.0	5710	8560	11600	14500		1600
	8.0	6300	9440	12800	16000		1400
	7.0	6690	10200	13700	17200		1300
	6.0	7130	10800	14500	18200		1100
	5.0	7570	11400	15200	19100		900
	4.0	7960	12100	16000	20000		690



Service instructions
3/8-24 UNF: max. 30 lbf ft

Measuring procedure: Room temperature / Force-height-data quasistatic / Dynamic data at 1 Hz