

## FT 2870-45 RS

## Triple Convolution Air Actuator

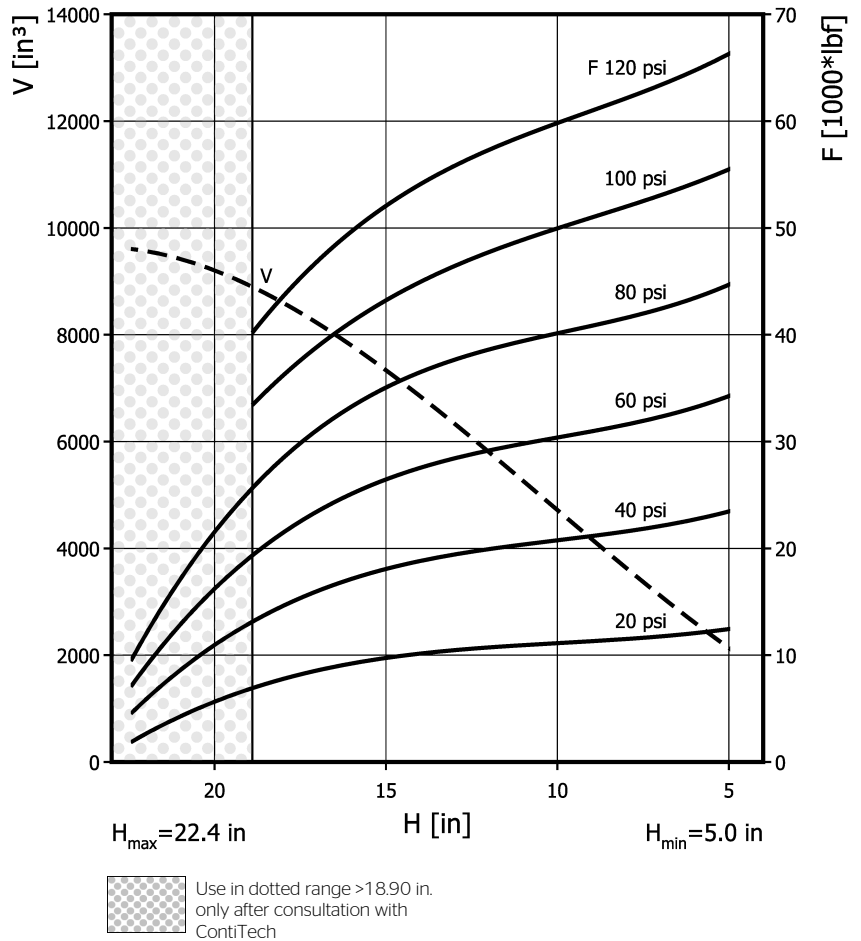
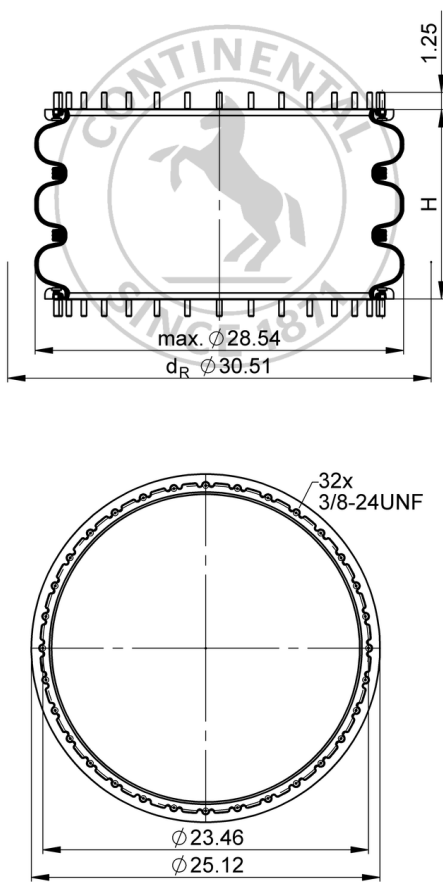

## Purchase order data

Type	Order No.
rubber bellows only	61790
with bead rings, 1 3/4in bolts, nuts and washers	65755

Additional types on request

## Technical data

Min. pressure	0	psi
Return force to min height	≤ 214	lbf
Overall weight	37.5	lb

## Pneumatic application - static characteristic values

Force F [lbf]							
Pressure p	[psi]	40	60	80	100	120	Vol. V [in.³]
Height H [in.]	20.0	10900	16000	21200			9200
	17.5	15300	22700	30200	37600	45200	8300
	15.0	17800	26200	34700	43100	51900	7300
	12.5	19700	28600	38000	47300	56600	6200
	10.0	20700	30400	40100	49700	60000	4900
	7.5	21900	32100	42300	52700	62500	3100

 Service instructions  
 3/8-24 UNF: max. 30 lbf ft

Measuring procedure: Room temperature / Force-height-data quasistatic / Dynamic data at 1 Hz