

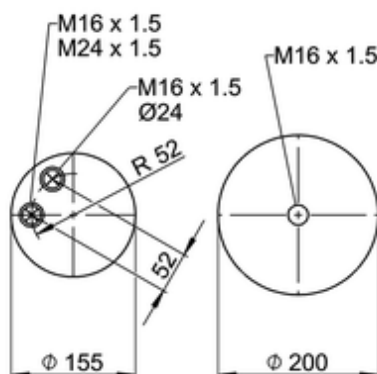

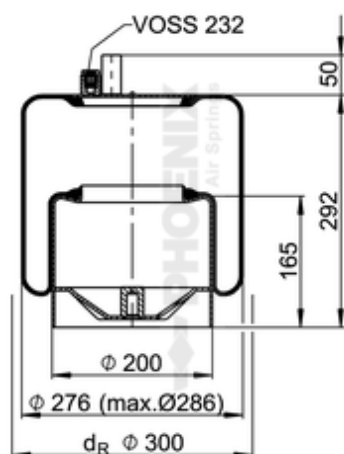



1 KF 21-22

71999



● bolt or stud ○ hole ⊗ combination stud ⊗ air inlet

	7,1 kg
	K021
	
	M16x1.5: max. 130 Nm
	M16x1.5: max. 25 Nm
	M24x1.5: max. 100 Nm

OE Manufacturer/Part No.

Manufacturer	Original Part No.	Model
Mercedes	942 320 29 21	
Mercedes	942 320 50 21	
Mercedes	A 942 320 50 21	Actros
Mercedes	A 942 320 29 21	Actros MP2

